

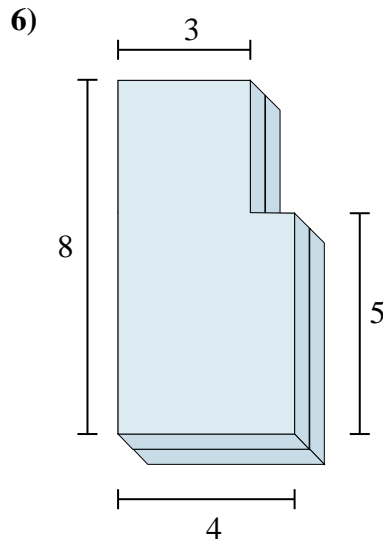

Bestimme das Gesamtvolumen jeder gezeigten Figur. Einheiten sind in cm und nicht maßstäblich.

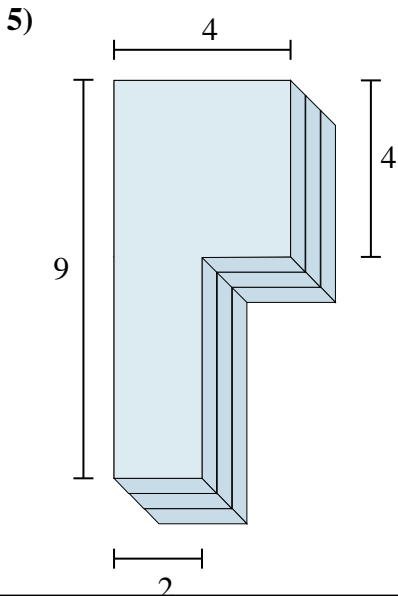
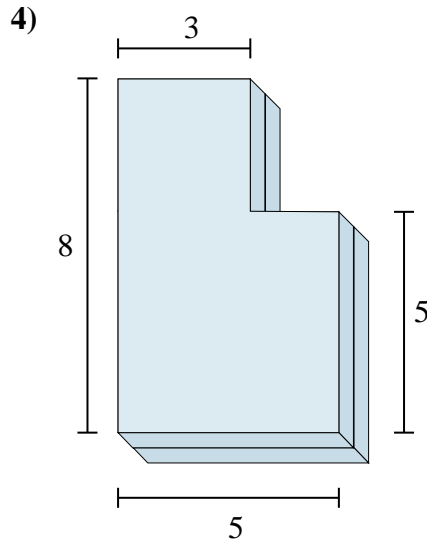
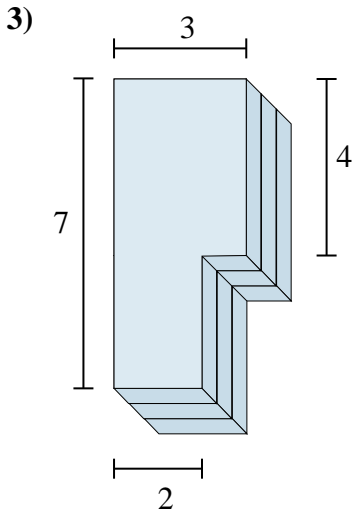
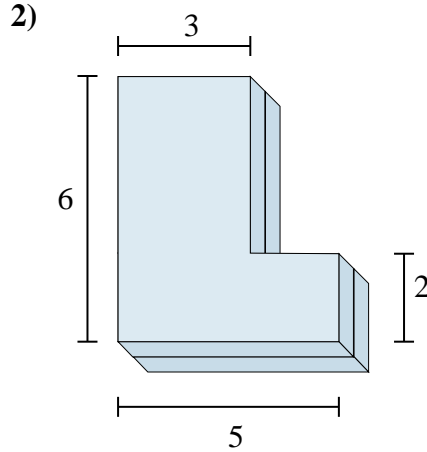
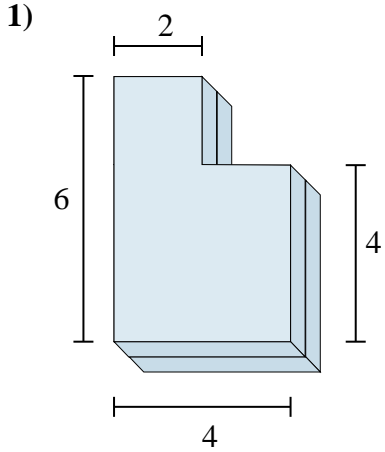

Antworten

- 1. _____
- 2. _____
- 3. _____
- 4. _____
- 5. _____
- 6. _____

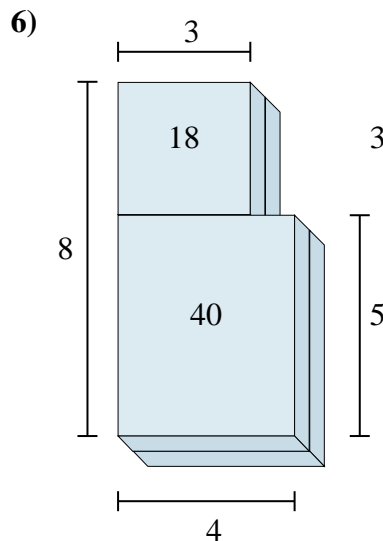
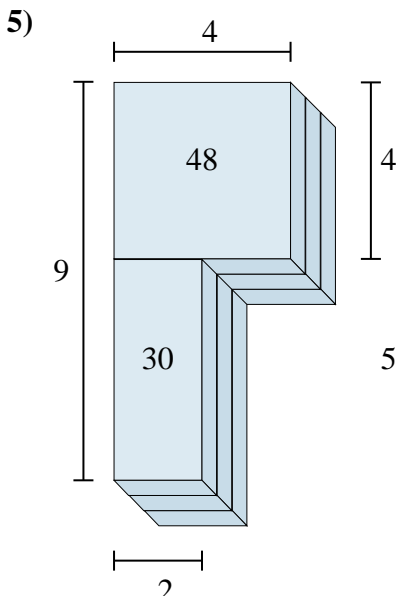
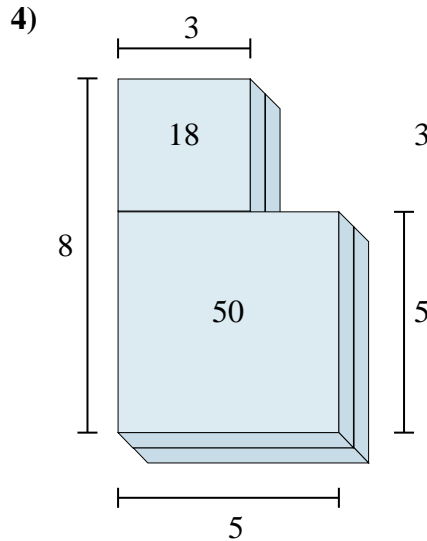
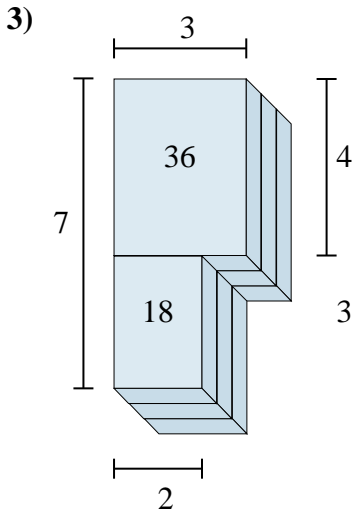
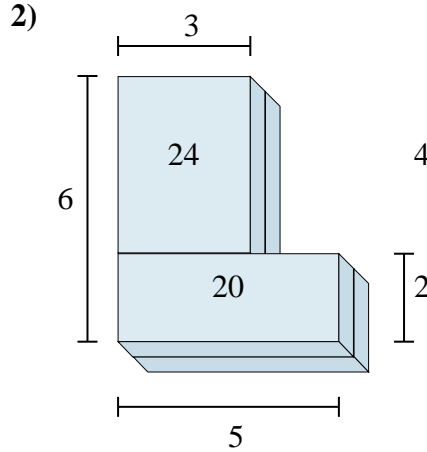
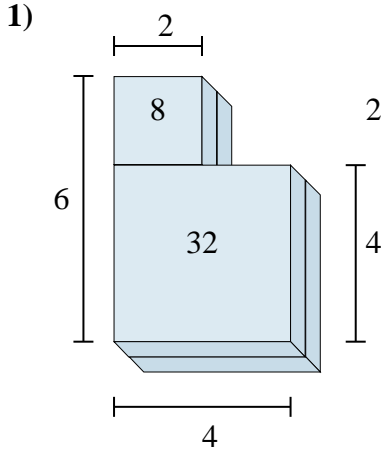

Bestimme das Gesamtvolumen jeder gezeigten Figur. Einheiten sind in cm und nicht maßstäblich.

**Antworten**1. 40 cm³2. 44 cm³3. 54 cm³4. 68 cm³5. 78 cm³6. 58 cm³



Bestimme das Gesamtvolumen jeder gezeigten Figur. Einheiten sind in cm und nicht maßstäblich.

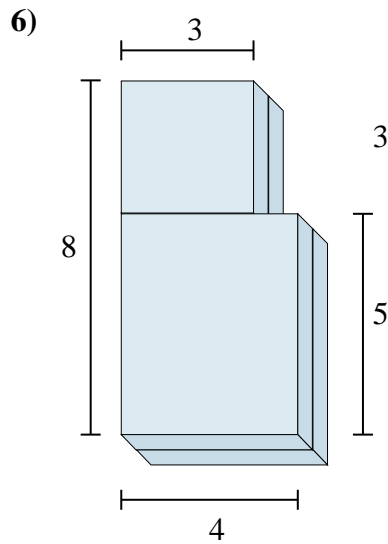
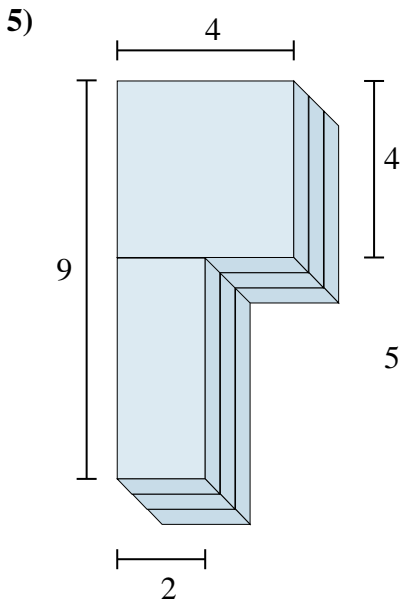
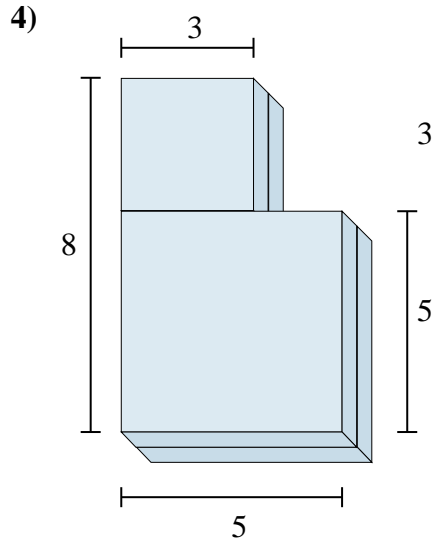
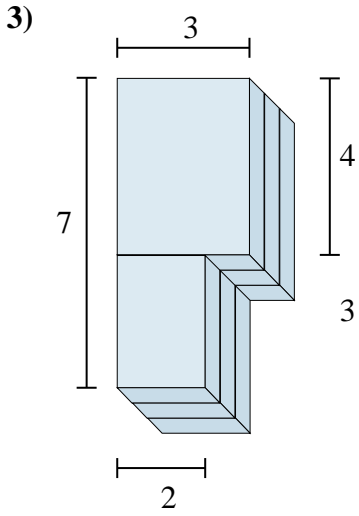
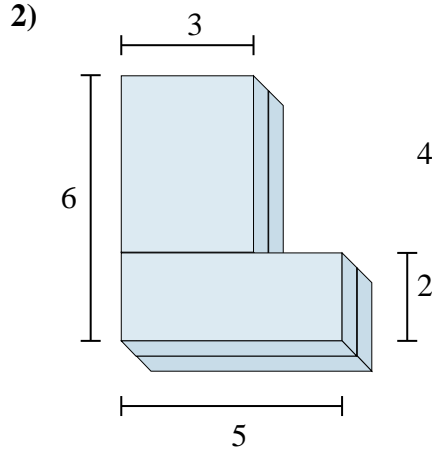
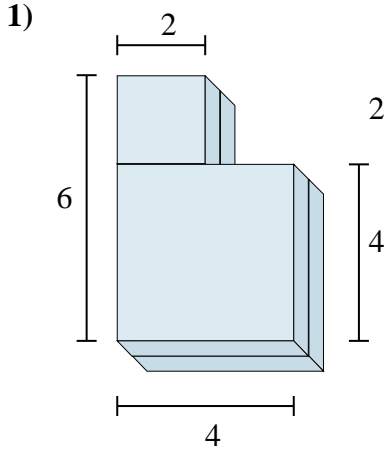

Antworten

1. _____
2. _____
3. _____
4. _____
5. _____
6. _____