

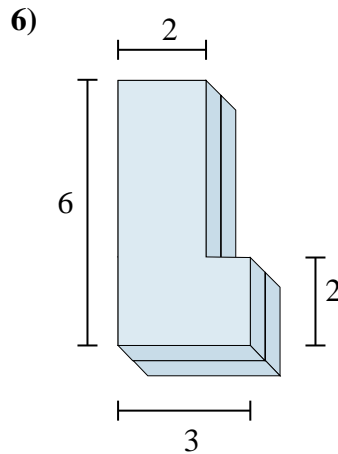

Bestimme das Gesamtvolumen jeder gezeigten Figur. Einheiten sind in cm und nicht maßstäblich.

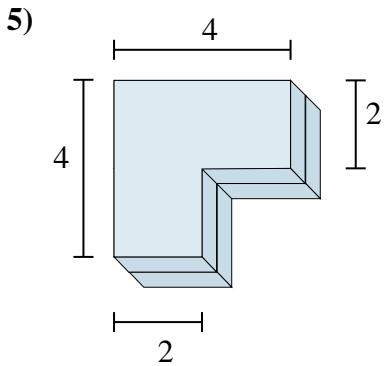
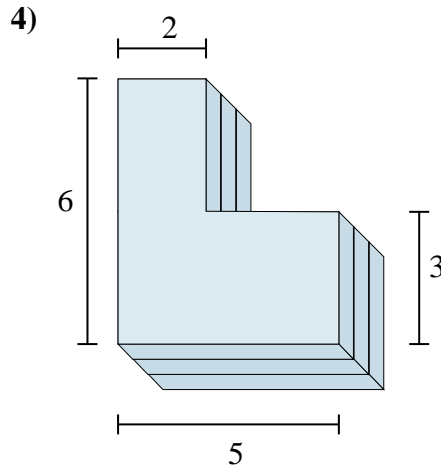
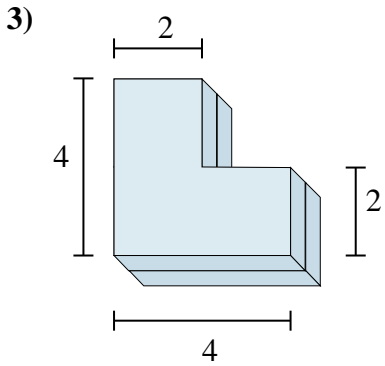
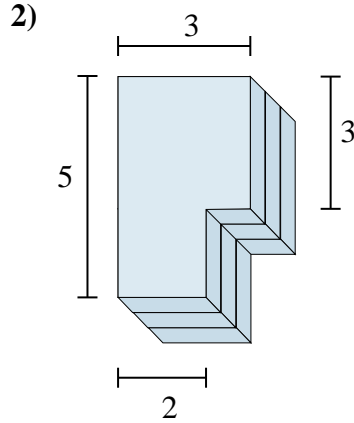
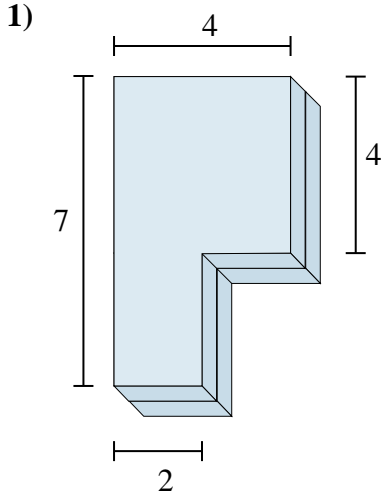

Antworten

- 1. _____
- 2. _____
- 3. _____
- 4. _____
- 5. _____
- 6. _____

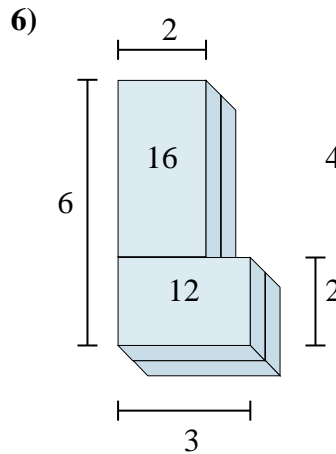
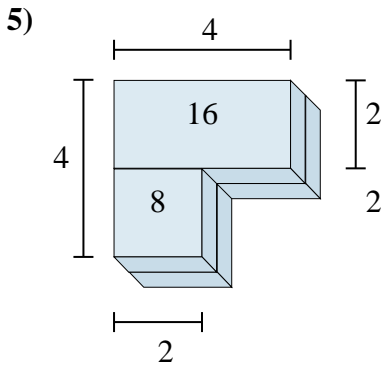
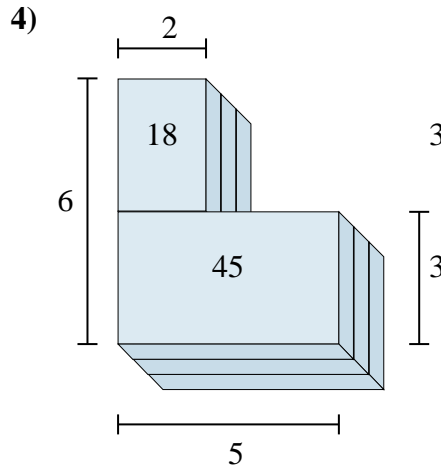
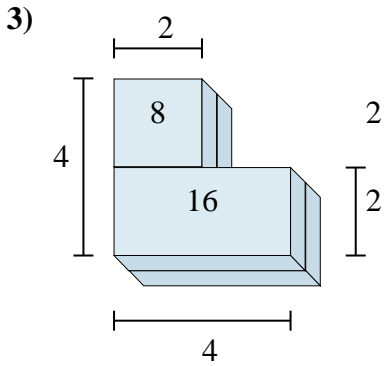
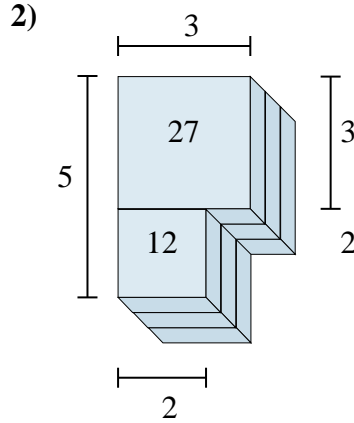
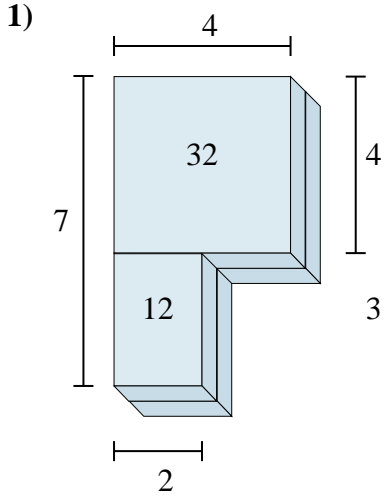

Bestimme das Gesamtvolumen jeder gezeigten Figur. Einheiten sind in cm und nicht maßstäblich.

**Antworten**

1. 44 cm³
2. 39 cm³
3. 24 cm³
4. 63 cm³
5. 24 cm³
6. 28 cm³



Bestimme das Gesamtvolumen jeder gezeigten Figur. Einheiten sind in cm und nicht maßstäblich.

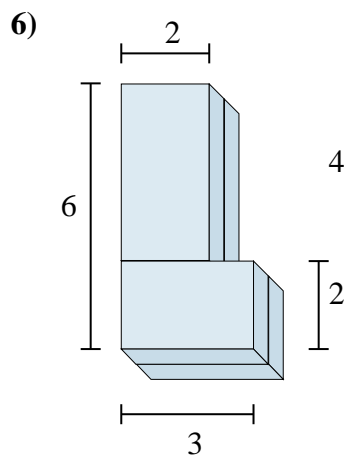
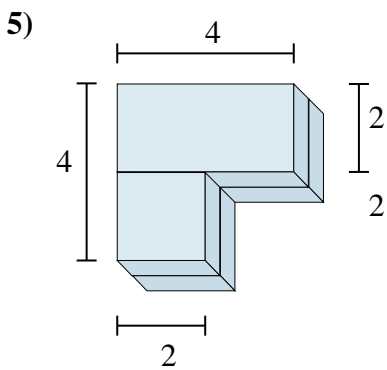
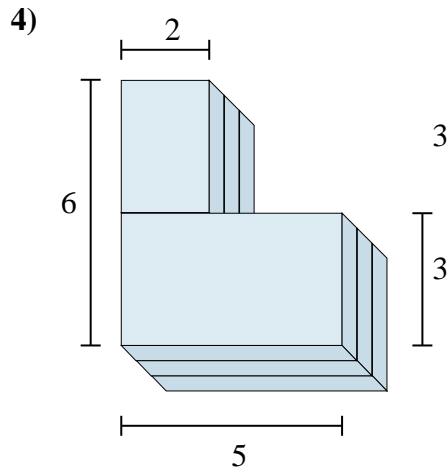
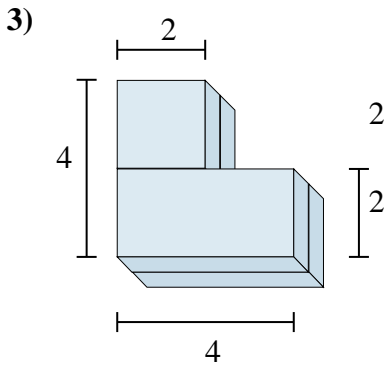
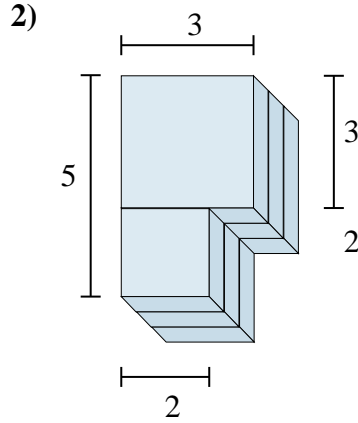
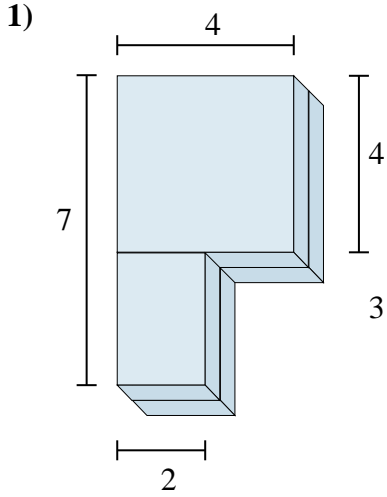

Antworten

1. _____
2. _____
3. _____
4. _____
5. _____
6. _____