

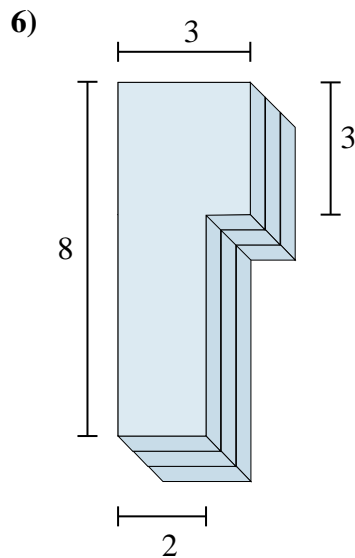

Bestimme das Gesamtvolumen jeder gezeigten Figur. Einheiten sind in cm und nicht maßstäblich.

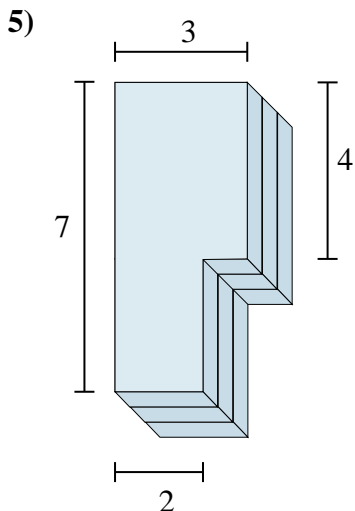
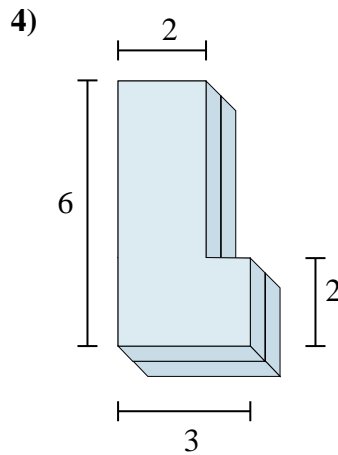
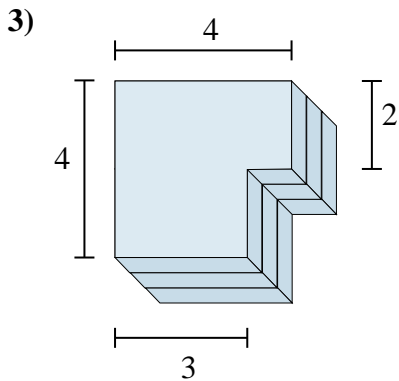
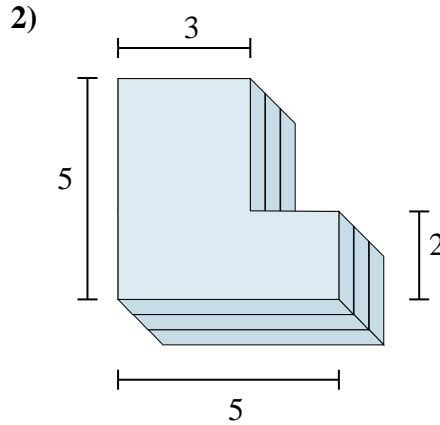
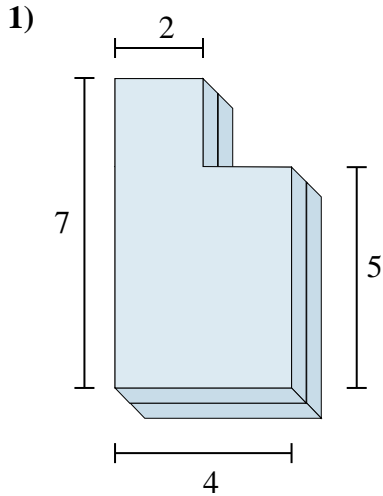

Antworten

- 1. _____
- 2. _____
- 3. _____
- 4. _____
- 5. _____
- 6. _____



Bestimme das Gesamtvolumen jeder gezeigten Figur. Einheiten sind in cm und nicht maßstäblich.

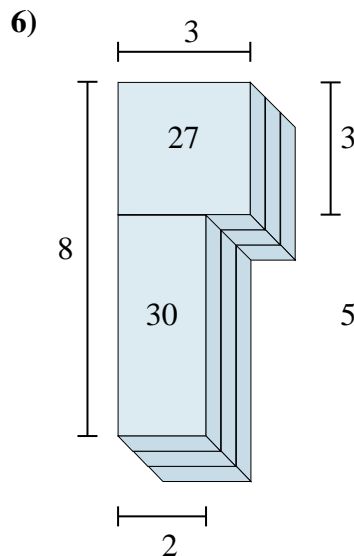
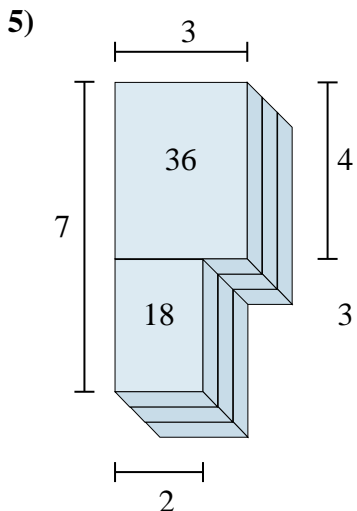
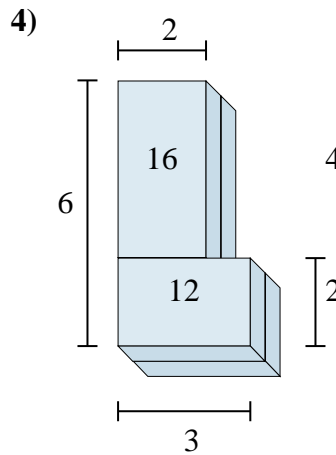
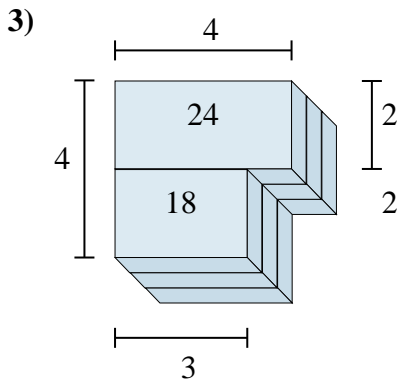
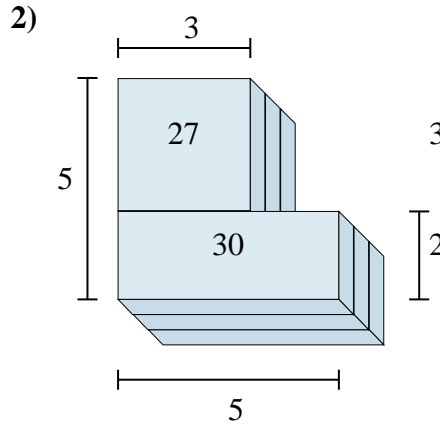
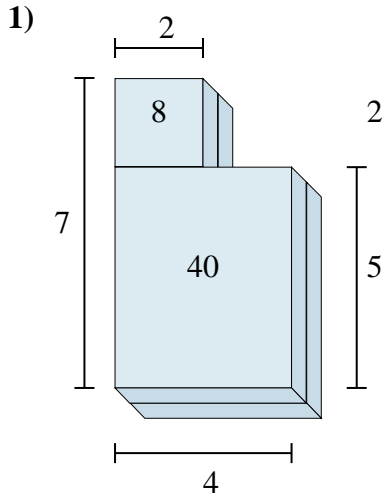

Antworten

1. 48 cm³
2. 57 cm³
3. 42 cm³
4. 28 cm³
5. 54 cm³
6. 57 cm³



Bestimme das Gesamtvolumen jeder gezeigten Figur. Einheiten sind in cm und nicht maßstäblich.

Antworten

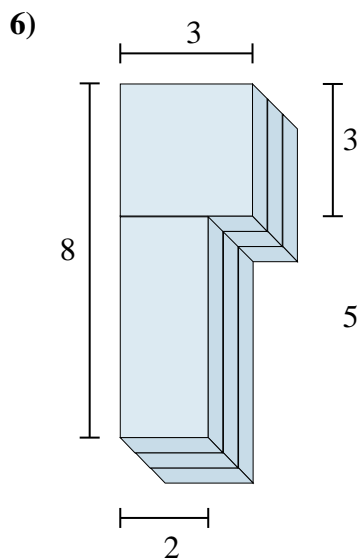
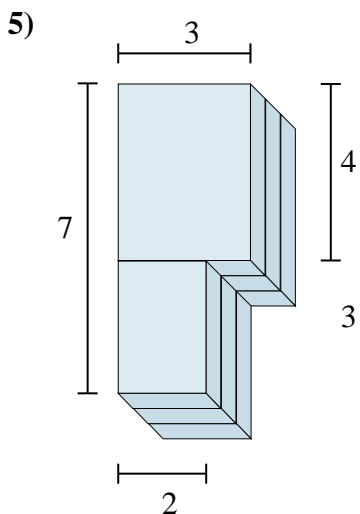
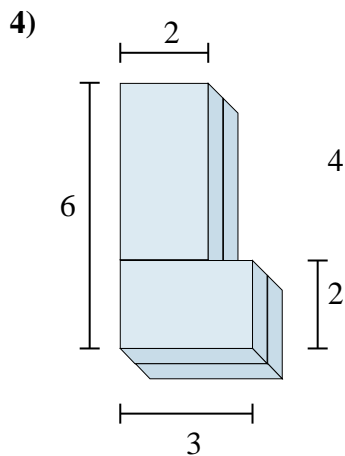
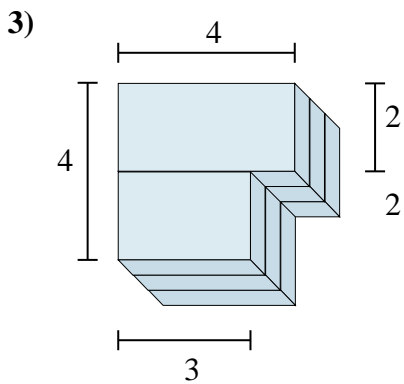
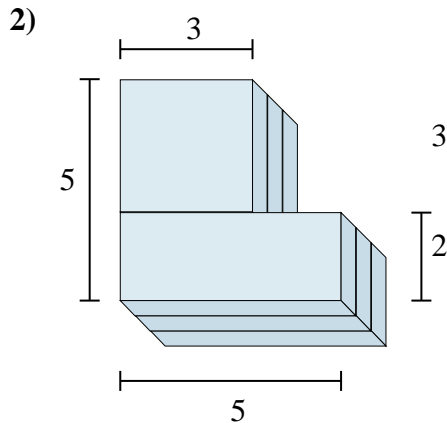
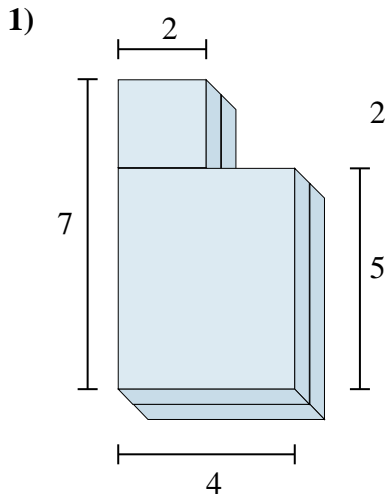

1. _____
2. _____
3. _____
4. _____
5. _____
6. _____